



CVWSV30Z-SS







30 inch 600 CFM Wall Mount Range Hood

This Caloric Wall Mount Range Hood is the perfect addition to your kitchen. It features 600 CFM of power for efficient ventilation, three speeds of operation to fit your cooking needs, and LED lighting for optimal illumination.

Its stainless-steel baffle filters are washable and provide efficient air filtration, while having a low noise level of between 1.0 Sone (min) and 5.0 Sone (max). Enjoy the convenience of Electronic Touch Control and top venting, with a 6" round exhaust for compatibility with different kitchen types.

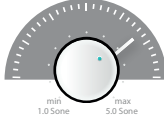
Rest easy with a 1-year parts and labour warranty. An optional recirculating kit is available, as well as a chimney extension to offer you the option to install the hood on a higher ceiling.



Features	Benefits	
600 CFM Motor, with 3 Speed Settings	Creates powerful, flexible and efficient ventilation to quickly remove smoke and odors from the kitchen	
LED Lighting	Powerful, bright, illuminating light for better visibility in the kitchen	
Sound levels: 1 Sone (Min) - 5 Sones (Max)	Low noise levels while providing powerful ventilation.	
Stainless Steel Baffle Filters	Easy-to-maintain, durable and washable for long-lasting performance.	
Electronic Touch Controls	Easy to use and intuitive controls to quickly adjust the hood's settings	
110V/60Hz	Compatible with the standard electricity supply	

Features	Benefits	
Top Venting - 6" Round Exhaust	Compatible exhaust system for different types of kitchens. Easily fits in any kitchen design, in tight spaces.	
Premium Stainless Steel - Type 201	Stronger and thicker stainless steel is more corrosion resistant and non-magnetic.	
1 Year Parts and Labour Warranty	Peace of mind and provides confidence that your Wall Mount Hood will work reliably and effectively for years to come.	
Optional Recirculating Kit	Ability to recirculate air in the kitchen	
Optional Chimney Extension	Ability to install the hood at a higher ceiling	
Optional Plasma Filtration Kit	Ability to recirculate and clean the air in your kitchen without costly filter replacements	

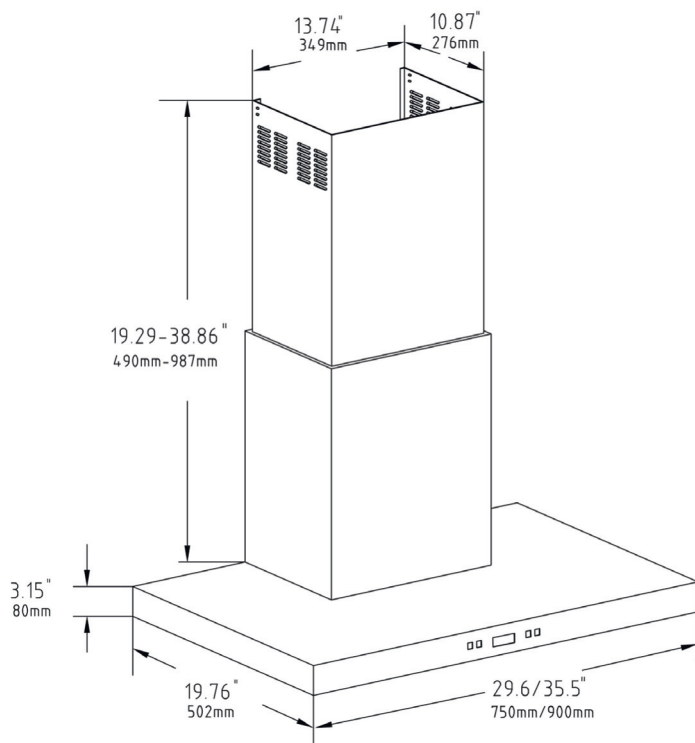

CVWSV30Z-SS



Weights & Dimensions Specification

Width	29.6"
Depth	19.76"
Height	24.5" Min / 42" Max
Weight	39.5 lbs
Carton	33" x 18" x 22"

Brought to you by



UPC code
6284518520524

844-455-3474 | info@caloricappliances.ca

2023 In Canada, Caloric™ is a registered trademark of J.A.K. North America Inc.
Specifications are for planning purposes only and are subject to change, Refer to installation instructions.