



CVWSV30F-SS





30 Inch 600 CFM Wall Mount Range Hood



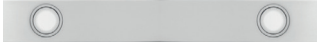

This Caloric Wall Mount Range Hood is the ultimate addition to your kitchen. It features 600 CFM of power for quick and effective ventilation, three speeds to operate at, and LED lighting for optimal visibility in your cooking area.

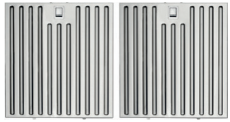
Its stainless-steel baffle filters are washable and provide efficient air filtration, while the low noise level of 5.0 Sones (max) to make your cooking experience much more enjoyable.

Enjoy the convenience of electronic touch controls and top venting, with a 6" round exhaust for flexibility exhausting in tight spaces. An optional recirculating kit is available, while an optional chimney extension offers the ability to install the hood on a higher ceiling. A 1-year parts and labour warranty enable you to rest easy.

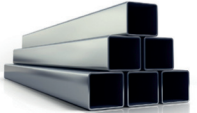

Features	Benefits	
600 CFM Motor with 3 Speed Settings	Creates powerful, flexible and efficient ventilation to quickly remove smoke and odors from the kitchen	
LED Lighting	Powerful, bright, illuminating light for better visibility in the kitchen	
Sound Levels: 1 Sone (Min) - 5 Sones (Max)	Low noise levels while providing powerful ventilation.	
Stainless Steel Baffle Filters	Easy-to-maintain, durable and washable.	
Electronic Touch Controls	Easy to use and intuitive controls to quickly adjust the hood's settings	
110V/60Hz	Compatible with the standard electricity supply	

Features	Benefits	
Top Venting - 6" Round Exhaust	Flexible exhaust system for different types of kitchens. Easily fits in any kitchen design, in tight spaces	
Premium Stainless Steel - Type 201	Stronger and thicker stainless steel is more corrosion resistant and non-magnetic.	
1 Year Parts and Labour Warranty	Peace of mind and provides confidence that your Undercabinet Hood will work reliably and effectively for years to come.	
Optional Recirculating Kit	Ability to recirculate air in the kitchen	
Optional Chimney Extension	Ability to install the hood on a higher ceiling	
Optional Plasma Filtration Kit	Ability to recirculate and clean the air in your kitchen without costly filter replacements	

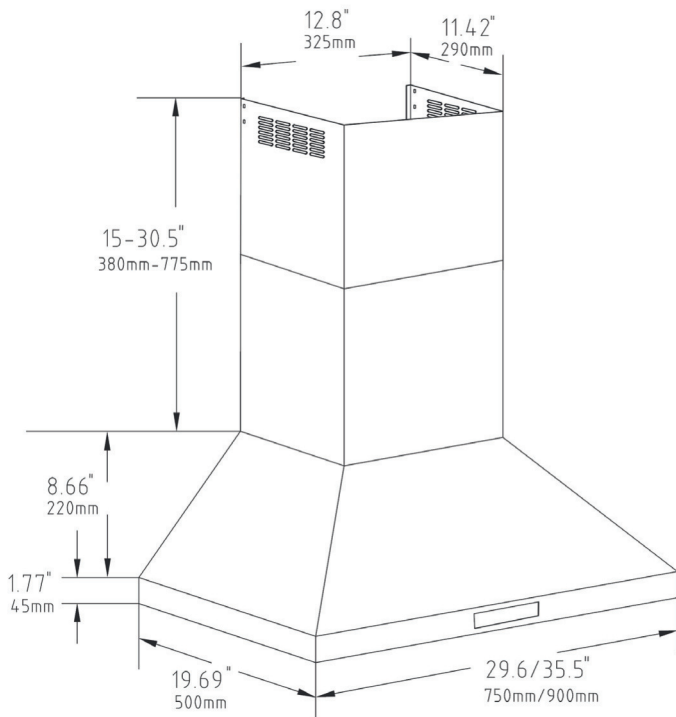

CVWSV30F-SS



Weights & Dimensions Specification

Width	29.6"
Depth	19.69"
Height	40.93"
Weight	36.74 lbs
Carton	33" x 18" x 23"

Brought to you by



UPC code
6284518520517

844-455-3474 | info@caloricappliances.ca

2023 In Canada, Caloric™ is a registered trademark of J.A.K. North America Inc.
Specifications are for planning purposes only and are subject to change, Refer to installation instructions.